

# TBH71, TBH72 TBH81, TBH82

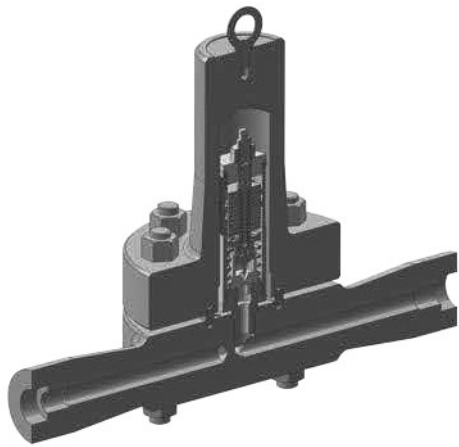

**TBH72, TBH81, TBH82**  
Socket Weld



**TBH71**  
Flanged

## Dimensions

**TBH71- ...W**  
Socket Weld

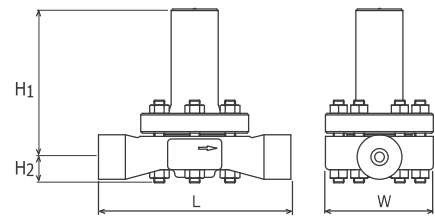

**TBH71- ...F**  
Flanged

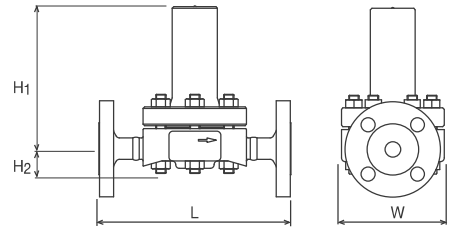

**TBH72- ...W, TBH81- ...W, TBH82- ...W**  
Socket Weld

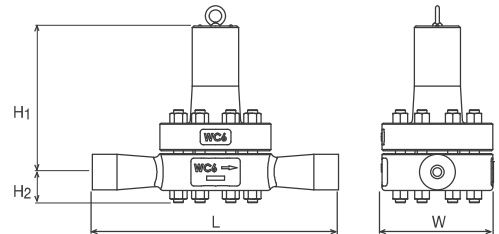

**TBH72- ...F, TBH81- ...F, TBH82- ...F**  
Flanged

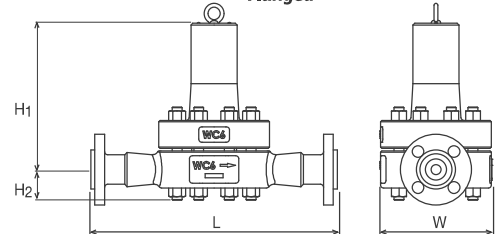

## Standard factory settings

Model	MPa	psig	Model	MPa	psig
<b>TBH71-80</b>	6,5 (210°C)	942 (410°F)	<b>TBH72-80</b>	6,5 (210°C)	942 (410°F)
<b>TBH71-105</b>	8,0 (230°C)	1160 (446°F)	<b>TBH72-105</b>	8,0 (230°C)	1160 (446°F)
<b>TBH81-150</b>	10,5 (250°C)	1522 (482°F)	<b>TBH82-150</b>	10,5 (250°C)	1522 (482°F)
<b>TBH81-200</b>	15,0 (270°C)	2175 (518°F)	<b>TBH82-200</b>	15,0 (270°C)	2175 (518°F)

## Pressure shell design conditions

Model	PMA		TMA	
	MPa	psig	°C	°F
<b>TBH71-80</b>	11,8 (425°C)	1711 (800°F)	593 (1,3MPa)	1100 (188 psig)
<b>TBH71-105</b>				
<b>TBH72-80</b>	25,0 (492°C)	3625 (918°F)	593 (3,7MPa)	1100 (536 psig)
<b>TBH72-105</b>				
<b>TBH81-150</b>	25,0 (492°C)	3625 (918°F)	593 (3,7MPa)	1100 (536 psig)
<b>TBH81-200</b>				
<b>TBH82-150</b>	25,0 (520°C)	3625 (968°F)	593 (5,9MPa)	1100 (856 psig)
<b>TBH82-200</b>				
	25,0 (538°C)	3625 (1000°F)	593 (7,3MPa)	1100 (1059 psig)

Model	Connections	Size	Operating Pressure Range		Max. Operating Temperature		Adjustable Range		Dimensions (mm)				Dimensions (in)				Body Material	Weight	
			MPa	psig	°C	°F	°C	°F	L	H1	H2	W	L	H1	H2	W		kg	lb
<b>TBH71-80W</b>	Socket Weld JIS, ASME, DIN	½" – 1"	1,0 – 8,0	145 – 1160	470	878	100 – 260	212 – 500	250	195	33	140	9.8	7.7	1.3	5.5	Cast Steel A217WC6	13	28.6
<b>TBH71-105W</b>			1,0 – 10,5	145 – 1522			100 – 280	212 – 536										13	28.6
<b>TBH81-150W</b>			2,0 – 15,0	290 – 2175			100 – 300	212 – 572										29	63.8
<b>TBH81-200W</b>			2,0 – 20,0	290 – 2900			100 – 320	212 – 608										29	63.8
<b>TBH71-80F</b>	Flanged JIS, ASME, DIN	½" – 1"	1,0 – 8,0	145 – 1160	470	878	100 – 260	212 – 500	260	195	33	140	10.2	7.7	1.3	5.5	Cast Steel A217WC6	19*	41.8*
<b>TBH71-105F</b>			1,0 – 10,5	145 – 1522			100 – 280	212 – 536										19*	41.8*
<b>TBH81-150F</b>			2,0 – 15,0	290 – 2175			100 – 300	212 – 572										38*	83.6*
<b>TBH81-200F</b>			2,0 – 20,0	290 – 2900			100 – 320	212 – 608										38*	83.6*

Model	Connections	Size	Operating Pressure Range		Max. Operating Temperature		Adjustable Range		Dimensions (mm)				Dimensions (in)				Body Material	Weight	
			MPa	psig	°C	°F	°C	°F	L	H1	H2	W	L	H1	H2	W		kg	lb
<b>TBH72-80W</b>	Socket Weld JIS, ASME, DIN	½" – 1"	1,0 – 8,0	145 – 1160	550	1022	100 – 260	212 – 500	400	268	50	180	15.7	10.6	2.0	7.1	A217WC6	29	63.8
<b>TBH72-105W</b>			1,0 – 10,5	145 – 1522			100 – 280	212 – 536										29	63.8
<b>TBH82-150W</b>			2,0 – 15,0	290 – 2175			100 – 300	212 – 572										37	81.4
<b>TBH82-200W</b>			2,0 – 20,0	290 – 2900			100 – 320	212 – 608										68	149.6
<b>TBH72-80F</b>	Flanged JIS, ASME, DIN	½" – 1"	1,0 – 8,0	145 – 1160	550	1022	100 – 260	212 – 500	400	268	50	180	15.7	10.6	2.0	7.1	A217WC6	35*	77.0*
<b>TBH72-105F</b>			1,0 – 10,5	145 – 1522			100 – 280	212 – 536										38*	83.6*
<b>TBH82-150F</b>			2,0 – 15,0	290 – 2175			100 – 300	212 – 572										46*	101.2*
<b>TBH82-200F</b>			2,0 – 20,0	290 – 2900			100 – 320	212 – 608										76*	167.2*

\* The weight refers to 1" flanged type. Depending on the size and flange standard the weights may differ.

Bimetal Temperature Control Trap – High Pressure **SERIES TB**

Capacity Charts

Temperature Stroke Charts

TBH71 - 80

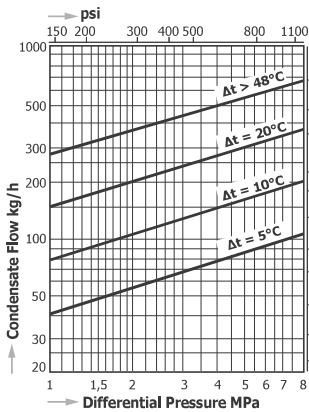

TBH72 - 80

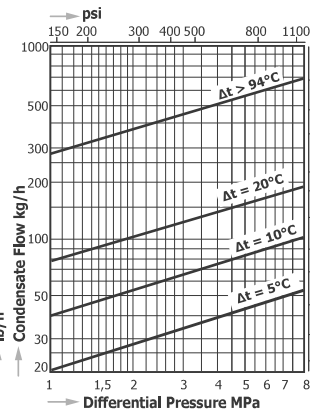

TBH71 - 80

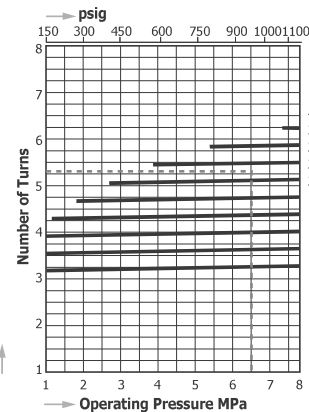

TBH72 - 80

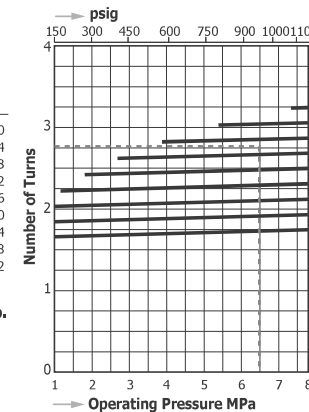

TBH71 - 105

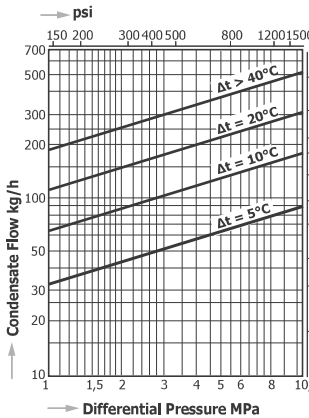

TBH72 - 105

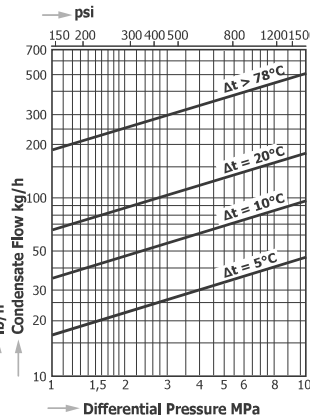

TBH71 - 105

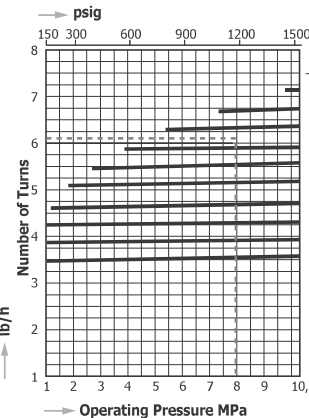

TBH72 - 105

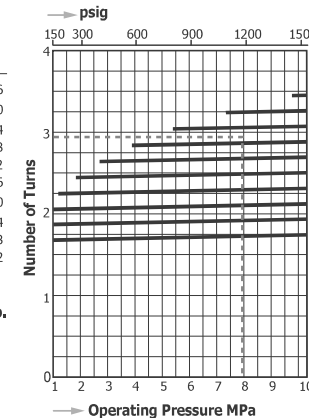

TBH81 - 150

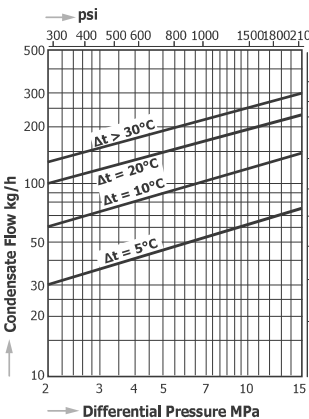

TBH82 - 150

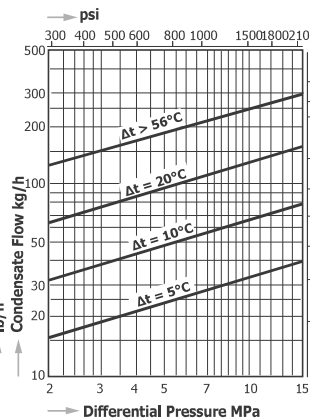

TBH81 - 150

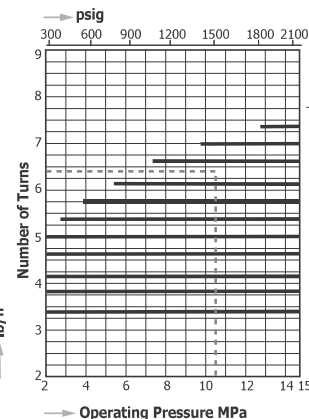

TBH82 - 150

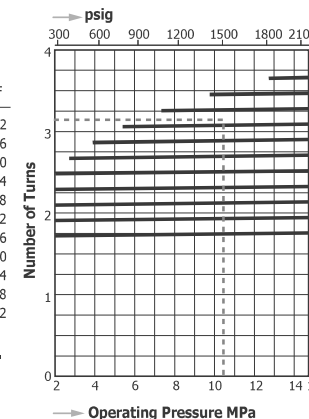

TBH81 - 200

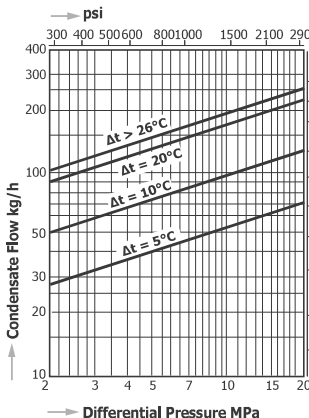

TBH82 - 200

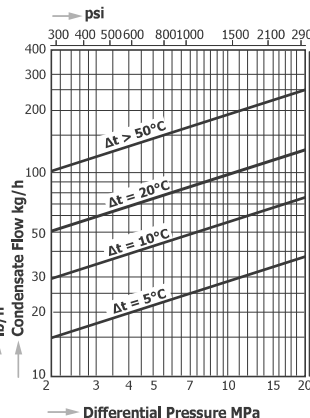

TBH81 - 200

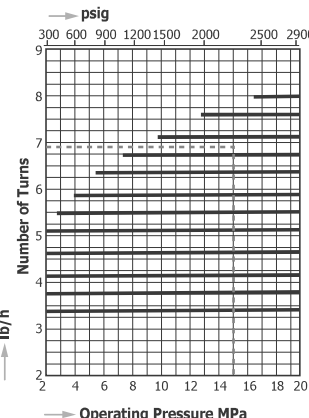

TBH82 - 200

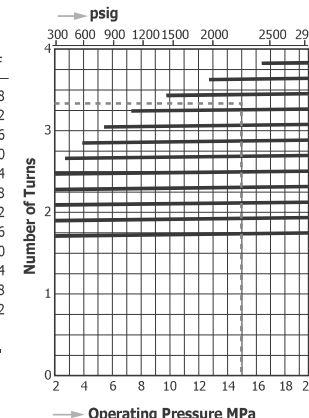

The dashed line shows the standard factory setting.